

DESIGN AND INSTALLATION OF RESIDENTIAL FLEXIBLE DUCTWORK SYSTEMS

A. SCOPE

1. This information is intended to assist contractors, installers and code officials in the proper design and installation of flexible ductwork systems. The information presented in this document comes primarily from sources in the International Mechanical Code including referenced standards and Georgia Amendments.
2. It is recommended as a guide that HVAC system documentation, including owner's manuals, manufacturer's installation instructions and a sketch of the duct system design that details duct size and approximate duct lengths be provided to the building owner or posted on the air handling unit or furnace. (See sample Duct System Design Sketch). Documentation should also include Manual J calculations.

B. GENERAL

1. The routing and length of flexible duct, the numbers of degrees of each bend and the amount of sag allowed between support joints will have serious effects on system performance due to the increased resistance each introduces. Use the minimum length of flexible duct to make connections. Do not install excess lengths of ducts to allow for possible future relocations of air terminal devices.
2. Flexible air duct trunk lines should not be limited in length. It is recommended as a guide that flexible air duct branch takeoffs (run-outs), flexible air ducts direct to boots from the plenum and flexible ducts in radial duct systems be limited in length to 25 feet (7620 mm). The preferred duct geometry is a "Trunk and Branch" system (see ACCA Manual D Figures 1-4 and 10-7).
3. Flexible air ducts, both metallic and nonmetallic, should be tested in accordance with UL 181. Such ducts should be listed and labeled as Class 0 or Class 1 flexible air ducts.
4. Flexible duct is for indoor use only; do not install product where exposure to direct sunlight can occur. Prolonged exposure to sunlight may cause deterioration of vapor barrier.
5. The inner core may degrade if the duct is positioned near a bio-treatment lamp (UV emitter) installed within the HVAC system.
6. Terminal devices should be supported independently of the flexible duct.
7. Repair torn or damaged vapor barrier/jacket with duct tapes listed and labeled to UL 181B; if internal core is penetrated, replace flexible duct or treat as a splice.

(see Section E below).

DESIGN AND INSTALLATION OF RESIDENTIAL FLEXIBLE DUCTWORK SYSTEMS

C. SYSTEM SIZING AND DESIGN

Flexible air duct systems should be sized and designed in accordance with ACCA Manual D for residential duct systems or other ICC referenced engineering standards based on the following:

1. Calculation of the supply air for each room should be based on the greater of the heating load or sensible cooling load for that room as determined by a heat loss/heat gain calculation per ACCA Manual J or the ASHRAE Handbook of Fundamentals.

2. Duct size should be determined by:

- a) The supply air requirements of each room.
- b) The available static pressure of the blower.
- c) The total equivalent length of the various duct runs, duct fittings and terminal devices.

3. Flexible duct and flexible connectors should be sized to deliver the required airflow (as calculated in Step 1 above) in strict accordance with the manufacturer's sizing recommendations, the ACCA Manual D friction chart (Appendix 2, Chart 7) or other appropriate IMC standards. (Flexible duct sizing calculators are available from manufacturers or industry associations).

4. The dwelling should be constructed with adequate space and chases to accommodate all flex ducts without them being compressed or bent in a radius less than one duct diameter, and to avoid bending across sharp corners or incidental contact with metal fixtures, pipes or conduits.

5. Sufficient space should be provided adjacent to all mechanical components located in or forming a part of the air distribution system to assure adequate access for:

- a) Construction and sealing
- b) Inspection
- c) Cleaning and maintenance

D. INSTALLATION

1. Install duct fully extended; do not install in the compressed state or use excess lengths. This will noticeably decrease friction losses.

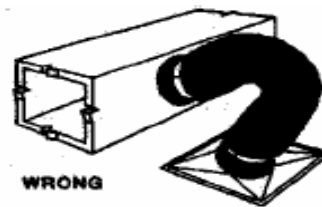
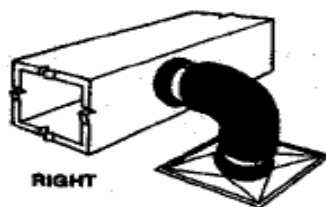

DESIGN AND INSTALLATION OF RESIDENTIAL FLEXIBLE DUCTWORK SYSTEMS

2. Avoid bending ducts across sharp corners or incidental contact with metal fixtures, pipes or conduits. Radius at center line should not be less than one duct diameter.
3. Do not install near hot equipment (e.g., furnaces, boilers, steam pipes, etc.) that is above the recommended flexible duct use temperature.
4. Do not use for vertical risers in air ducts systems serving more than two floors.
5. Avoid installations where exposure to direct or indirect sunlight or UV producing air treatment devices can occur. Prolonged exposure to sunlight or UV light may cause degradation of the core material or the vapor barrier.
6. Should not be installed within 4 inches (101.6 mm) of hot equipment (furnaces, boilers, steam pipes, etc.) that is above 250o F (121o C).
7. Should not penetrate walls where fire dampers are required.
8. Should not be installed in concrete, buried below grade or in contact with the ground.

E. CONNECTING AND SPLICING FLEXIBLE DUCT

1. All connections, joints and splices should be made in accordance with the manufacturer's installation instructions. (See flexible duct connections and splicing diagrams below).
2. All tapes, mastics and non-metallic fasteners (plastic clamps) used for field installation of flexible ducts should be listed and labeled to UL 181B, Closure Systems for Use With Flexible Air Ducts and Air Connectors. Non-metallic fasteners are limited to 6 inch w.g. (water gauge) maximum positive pressure.
3. Sheet metal collars to which flexible ducts are attached should be a minimum of 2 inches (50.8 mm) in length and should be beaded.
4. Sheet metal sleeves used for joining two sections of flexible duct should be a minimum of 4 inches (101.6 mm) in length and should be beaded on both ends.

DESIGN AND INSTALLATION OF RESIDENTIAL FLEXIBLE DUCTWORK SYSTEMS

Connections

1. After desired length is determined, cut completely around and through duct with knife or scissors. Cut wire with wire cutters. Fold back jacket and insulation.

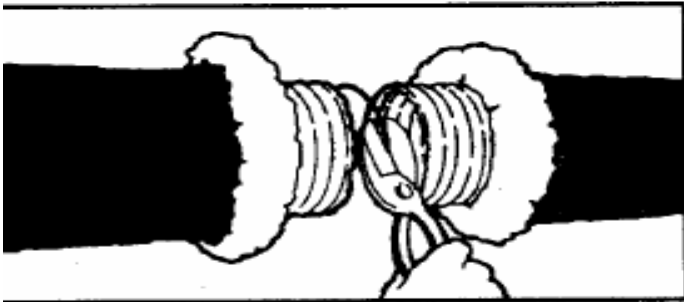

2. Slide at least 1" [25 mm] of core over fitting and past the bead. Seal core to collar with at least 2 wraps of duct tape. Secure connection with clamp placed over the core and tape and past the bead.

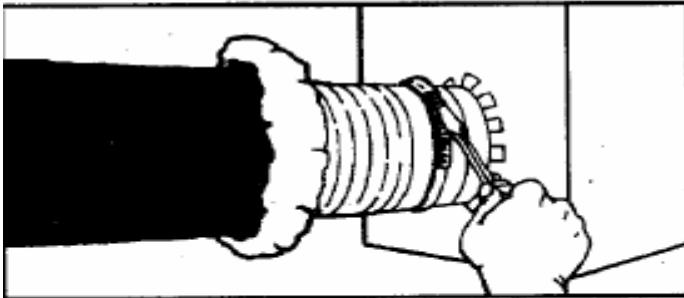

3. Pull jacket and insulation back over core. Tape jacket with at least 2 wraps of duct tape. A clamp may be used in place of or in combination with the duct tape.

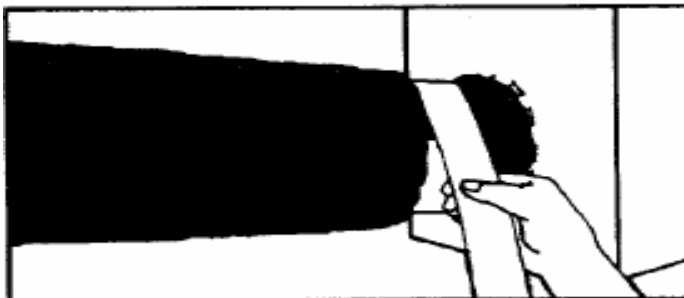

Splices

1. Fold back jacket and insulation from core. Butt two cores together on a 4" [100 mm] length metal sleeve.

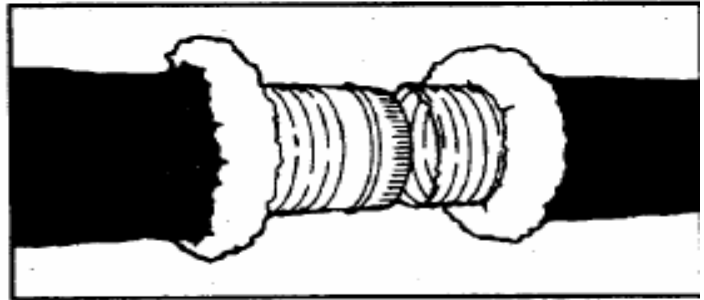

2. Tape cores together with at least 2 wraps of duct tape. Secure connection with 2 clamps placed over the taped core ends and past the beads.

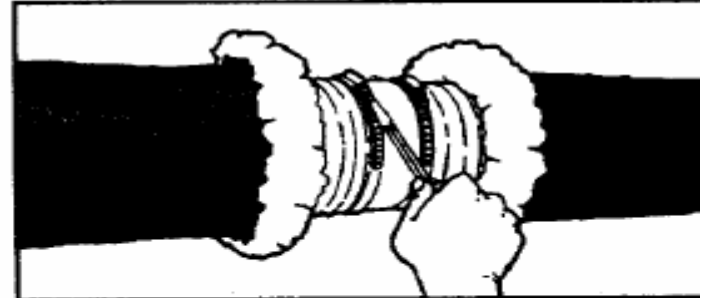

3. Pull jacket and insulation back over cores. Tape jackets together with at least 2 wraps of duct tape.

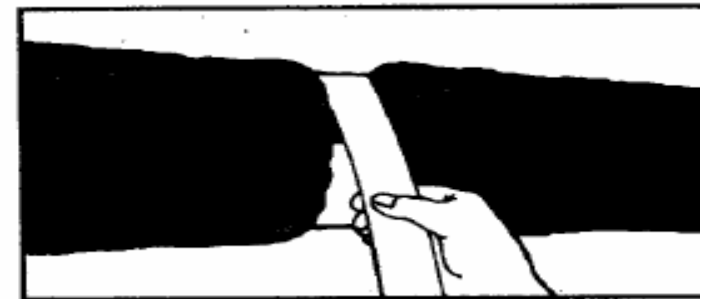

DESIGN AND INSTALLATION OF RESIDENTIAL FLEXIBLE DUCTWORK SYSTEMS

F. SUPPORTING FLEXIBLE DUCT

1. Flexible duct shall be supported at manufacturer's recommended intervals, but at no greater distance than 5 feet (1524 mm). Maximum permissible sag is $\frac{1}{2}$ inch per foot of spacing between supports.

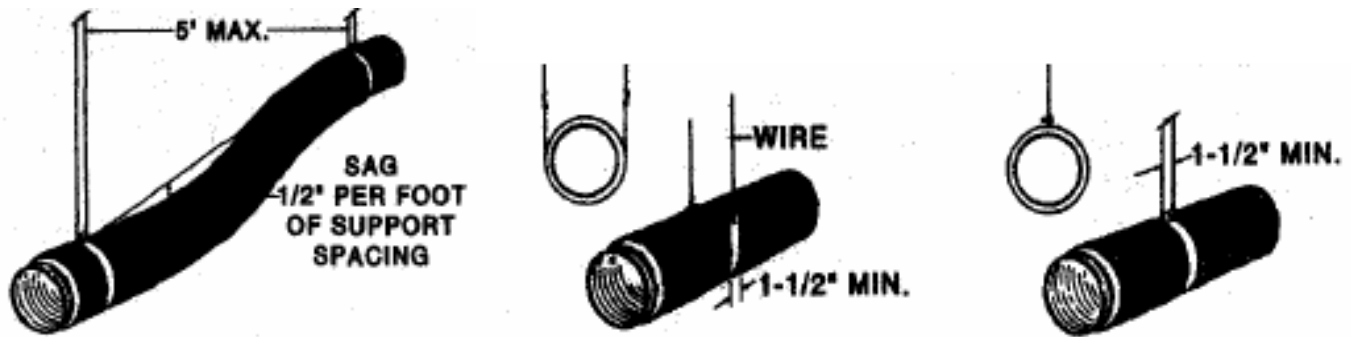

2. Hanger or saddle material in contact with the flexible duct should be of sufficient width (minimum $1\frac{1}{2}$ " (38 mm)) to prevent any restriction of the internal diameter of the duct when the weight of the supported section rests on the hanger. Individual ducts should be separately supported.

3. Flexible ducts may rest on ceiling joists or truss supports. Maximum spacing between supports should not exceed the maximum spacing per manufacturer's installation instructions.

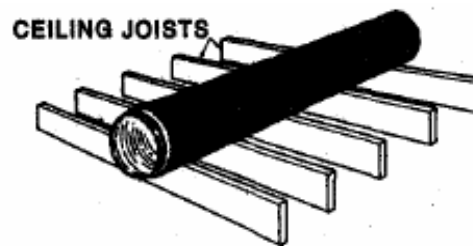

4. Support the duct between a metal connection and a bend by allowing the duct to extend straight for a few inches before making the bend.

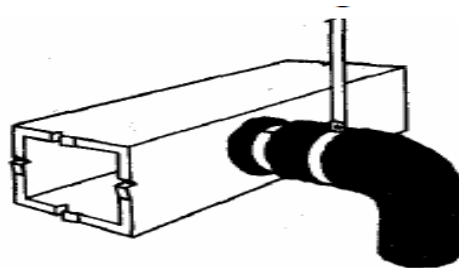

DESIGN AND INSTALLATION OF RESIDENTIAL FLEXIBLE DUCTWORK SYSTEMS

5. Vertically installed duct should be stabilized by support straps at a maximum of 6 feet (1829 mm) on center.

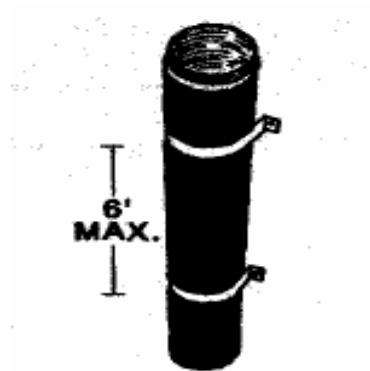

G. SOURCE MATERIAL

Information for these recommendations was compiled from these code sources:

- *International Mechanical Code, 2000 Edition, with 2001, 2004 & 2005 Georgia Amendments*
- *Flexible Duct Performance and Installation Standards (3rd ed.) – Air Diffusion Council*
- *Manual D—Residential Duct Systems – Air Conditioning Contractors of America (ACCA)*
- *HVAC Duct Construction Standards—Metal and Flexible (1995 ed.) – Sheet Metal and Air Conditioning Contractors' National Association, Inc. (SMACNA)*

Additional information was also compiled from these documents:

- *Uniform Mechanical Code, 2003 Edition, Appendix A: Standard for Installation of Factory-Made Air Ducts*
- *Florida Mechanical Code, Section 610: Air Distribution Systems*

DESIGN AND INSTALLATION OF RESIDENTIAL FLEXIBLE DUCTWORK SYSTEMS

DUCT SYSTEM DESIGN SKETCH

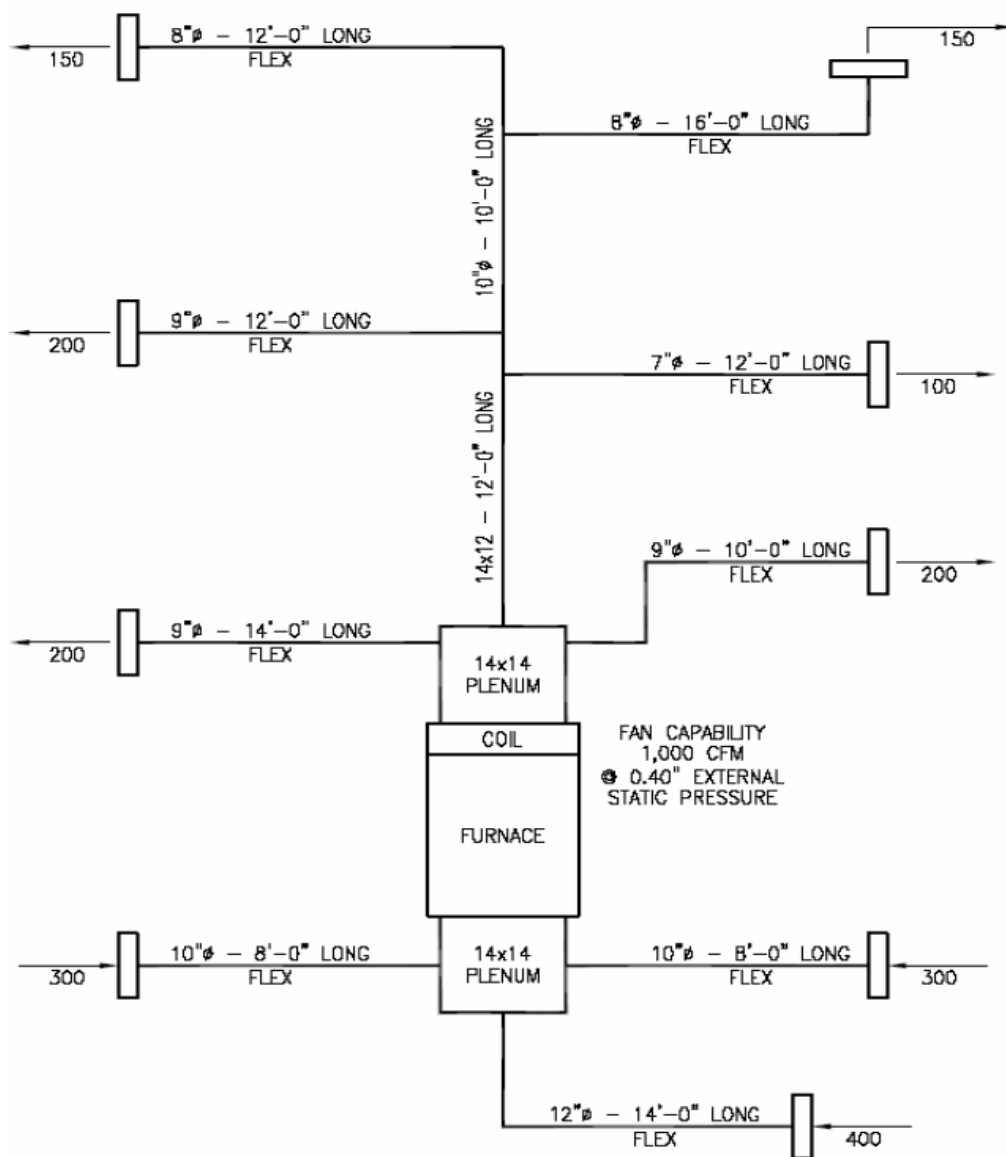

SIZES AND AIRFLOWS SHOWN AS AN EXAMPLE ONLY.